

Stainless Steel Push-In Fittings

...Make the leak free connections with Sealexcel products at economical price...



SEALEXCEL (INDIA) PVT. LTD.,

is a fast growing manufacturing company in the design, development, production and marketing of high quality products such as

- Twin ferrule tube fittings.
- Single ferrule tube fittings.
- 37° Flared tube fittings.
- Stainless steel push-in-fittings.
- Precision pipe fittings and adaptors.
- Bar stock and forged body needle valves.

SEALEXCEL manufactures all above products to very stringent tolerances under rigid quality controlled procedures approved to ISO 9001:2000 quality management systems and tested with continuous Research and Development backing to withstand the demand of high performance world class quality products for instrumentation and process tubings and used in the environments such as Oil, Gas, Chemical, Petrochemical, Nuclear, Power Plant, Pharmaceutical, Hydraulic, Marine, Packaging and Printing Industries etc.

SEALEXCEL has two manufacturing units in India having modern manufacturing facilities with CNC lathes, Single Spindle Auto Screw machines, Capsten Lathes, Thread Rolling and many other machines to provide good quality products at economical prices.

SEALEXCEL **Product Warranty:**

SEALEXCEL Products have a warranty of 12 months from the date of shipment against any defect in material or workmanship. This warranty is the replacement of determined defective parts only.

SEALEXCEL **Quality Policy:**

We at SEALEXCEL are committed to meet all customer's requirements and enhance customers expectations by providing them excellent products at economical price in time and by...

- ☞ Continually improving the products, process and systems,
- ☞ Involving all the employees and enhancing their competency,
- ☞ Complying with all applicable statutory and regulatory requirements.

SEALEXCEL **Aim:**

To make every efforts towards producing the **WORLD-CLASS** products at economical price.

SEALEXCEL



Stainless Steel Push-in-Fittings



Application:

SEALEXCEL Stainless Steel Push-in-Fittings are resistance to aggressive environments and corrosive fluids etc., which are generally used in Chemical, Food, Printing, Packaging, marine Pharmaceutical Industries etc.,

SEALEXCEL Stainless Steel Push-in-Fittings are compatible with,

- Semi-rigid nylon tube
- Flexible polyurethane tube
- Low density polyethylene tube
- Fluoropolymer FEP140 tube
- Stainless Steel and copper tube (when grooved)

Design:

SEALEXCEL Stainless Steel Push-in-Fittings consist of Six precision components such as Body, Releasing Sleeve, Washer, Gripping Collet, Guide Ring and 'O' Ring.

These components have been carefully designed and manufactured to very stringent tolerances under rigid quality control procedures approved to ISO 9001:2000 to provide a zero leak at all tubing connection in Instrumentation and process tubing.

Advantages:

SEALEXCEL Stainless Steel Push-in-Fittings are,

- Easy for manual connection and disconnection.
- No tools required for connection and disconnection.
- Full Flow without pressure drop.
- Automatic tube sealing with 'O' Ring and locking with gripping collet.

Surface treatment:

Each and every Stainless Steel components of SEALEXCEL Push-in-fittings are electropolished to ensure a corrosion resistant surface layer of chromium oxide which is passive.

Operating parameters:

Pressure : upto 290 PSI (20 bar)
Temperature : upto 150° C

Available sizes:

Metric size ranges from:
4mm through 16mm Tube OD

Fractional size ranges from:
3/16" through 5/8" Tube OD.

Recommended tolerance on tube ± 0.05 mm

Material of Construction:

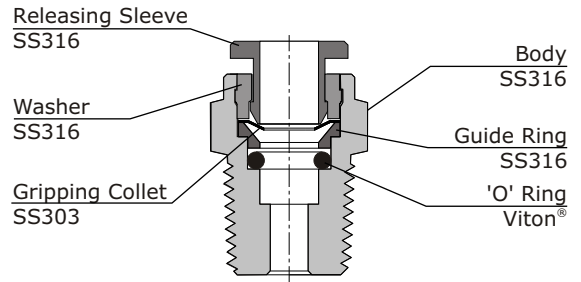

Note : 'O' Ring EPDM are available on request

The Stainless Steel 316 raw material meets the following specifications.

- a) SS-316 BAR STOCK : ASTM A-479
- b) SS-316 FORGING : ASTM A-182

Identifications:

SEALEXCEL Metric and Fractional size Stainless Steel Push-in-Fittings are similar in appearances.

The significant difference is in the internal diameter of the Push-in-Fittings components, hence for easy identifications between metric and fractional sizes. SEALEXCEL provided 'V' Groove on Fractional sizes Push-in-Fittings as shown below.

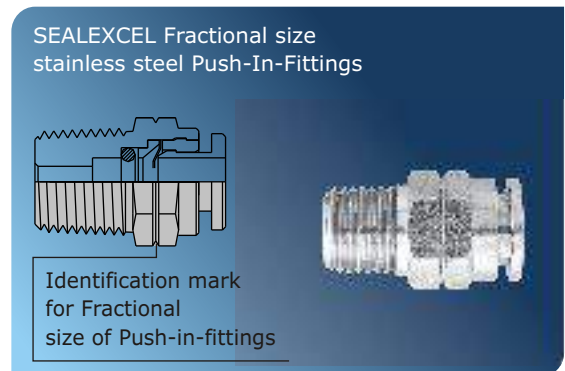
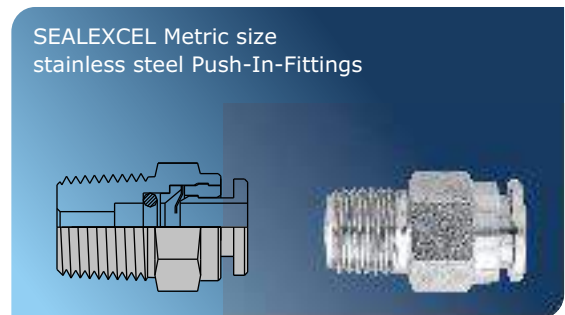

INSTALLATION INSTRUCTIONS:



- 1) For Tube : Semi-rigid Nylon Tube
Flexible polyurethane tube
Low density polyethylene tube
Fluoropolymer FEP140 tube

Ensure that the end of tube is cut square (90°) and free from burrs and sharp edges.

FOR TUBE : Stainless steel and Copper tube

Ensure that the end of the tube is cut square (90°) and chamfer the outer corner of tube, remove the burs and sharp edges to prevent the damages of 'O' Ring. Provide groove for tube gripping and locking.

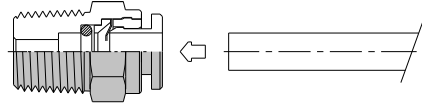

- 2) Insert the tube by hand into the fitting assembly resting it firmly against internal shoulder of the fittings. The Gripping collet hold the tube firmly in place, without deforming the tube or restriction flow.

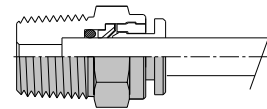

- 3) To release the Tube : Press the Releasing Sleeve and pull out the tube from fitting.

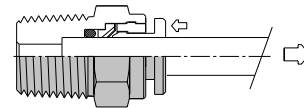

ORDERING INFORMATION:

The part Number describes complete assembly of SEALEXCEL Push-in Fittings.

Example: For Metric size : PIFTMC-6-250RT-EV

PIFTMC	6	250	RT	E	V
Type of Fitting	Tube OD	Pipe Thread	Type of Pipe Thread	Material	'O' RING
Taper Male Connector	6mm	1/4"	BSPT	SS 316	VITON®

Example: For Fractional size : PIFTMC-250-250N-EV

PIFTMC	250	250	N	E	V
Type of Fitting	Tube OD	Pipe Thread	Type of Pipe Thread	Material	'O' RING
Taper Male Connector	1/4"	1/4"	NPT	SS 316	VITON®

SIZE CODE DESCRIPTION:

Metric		Fractional	
Size	Code	Size	Code
4mm	4	3/16	187
6mm	6	1/4	250
8mm	8	5/16	312
10mm	10	3/8	375
12mm	12	1/2	500
14mm	14	5/8	625
16mm	16		

THREAD CODE DESCRIPTION:

Thread Type	Code
NPT Thread	N
ISO Tapered Thread (BSPT)	RT
ISO Parallel Thread (BSP) with Elastomeric 'O' Ring	EO
Metric Thread with Elastomeric 'O' Ring	MEO

MATERIAL CODE DESCRIPTION:

Description of Material	Code
SS316	E
'O' Ring Viton®	V
'O' Ring EPDM	P

VITON® - is the Registered Trademark of Dupont.

PIF - Taper male connector (PIFTMC)

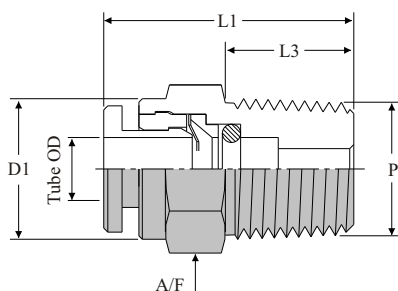

METRIC Tube to male BSPT

TUBE OD	P-PIPE THREAD	DIMENSIONS IN MILLIMETERS				SEALEXCEL PART NO.
		D1	L1	L3	A/F	
4 mm	1/8 BSPT	9.8	18.6	8.5	11.1	PIFTMC-4-125RT
4 mm	1/4 BSPT	9.8	23.0	12.5	14.2	PIFTMC-4-250RT
6 mm	1/8 BSPT	12.5	23.7	8.5	12.7	PIFTMC-6-125RT
6 mm	1/4 BSPT	12.5	23.7	12.5	14.2	PIFTMC-6-250RT
8 mm	1/8 BSPT	14.2	26.7	8.5	14.2	PIFTMC-8-125RT
8 mm	1/4 BSPT	14.2	27.7	12.5	14.2	PIFTMC-8-250RT
8 mm	3/8 BSPT	14.2	27.1	12.5	17.4	PIFTMC-8-375RT
10 mm	1/4 BSPT	16.4	29.0	12.5	17.4	PIFTMC-10-250RT
10 mm	3/8 BSPT	16.4	27.7	12.5	17.4	PIFTMC-10-375RT
12 mm	1/4 BSPT	19.0	32.4	12.5	20.6	PIFTMC-12-250RT
12 mm	3/8 BSPT	19.0	30.9	12.5	20.6	PIFTMC-12-375RT
12 mm	1/2 BSPT	19.0	32.4	16.5	22.2	PIFTMC-12-500RT
14 mm	3/8 BSPT	21.8	34.0	12.5	22.2	PIFTMC-14-375RT
14 mm	1/2 BSPT	21.8	34.4	16.5	22.2	PIFTMC-14-500RT
16 mm	1/2 BSPT	23.7	38.0	16.5	24.0	PIFTMC-16-500RT

Note : Metric Tube to male NPT are available on request.

FRACTIONAL Tube to male NPT

TUBE OD	P-PIPE THREAD	DIMENSIONS IN INCHES				SEALEXCEL PART NO.
		D1	L1	L3	A/F	
3/16	1/8 NPT	0.415	0.850	0.335	7/16	PIFTMC-187-125N
3/16	1/4 NPT	0.415	0.905	0.490	9/16	PIFTMC-187-250N
1/4	1/8 NPT	0.495	0.940	0.335	1/2	PIFTMC-250-125N
1/4	1/4 NPT	0.495	0.930	0.490	9/16	PIFTMC-250-250N
5/16	1/8 NPT	0.560	1.050	0.335	9/16	PIFTMC-312-125N
5/16	1/4 NPT	0.560	1.090	0.490	9/16	PIFTMC-312-250N
5/16	3/8 NPT	0.560	1.090	0.490	11/16	PIFTMC-312-375N
3/8	1/4 NPT	0.620	1.140	0.490	5/8	PIFTMC-375-250N
3/8	3/8 NPT	0.620	1.090	0.490	11/16	PIFTMC-375-375N
1/2	1/4 NPT	0.780	1.275	0.490	13/16	PIFTMC-500-250N
1/2	3/8 NPT	0.780	1.215	0.490	13/16	PIFTMC-500-375N
1/2	1/2 NPT	0.780	1.260	0.650	7/8	PIFTMC-500-500N
5/8	1/2 NPT	0.935	1.495	0.650	15/16	PIFTMC-625-500N

Dimensions are for reference only, subject to change without notice

PIF - Taper male elbow (PIFTME)

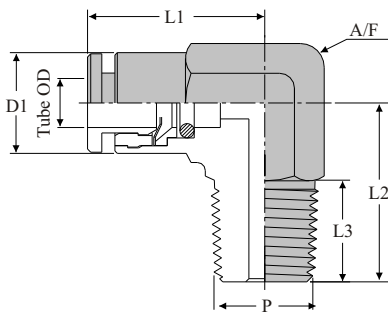

METRIC Tube to male BSPT

TUBE OD	P-PIPE THREAD	DIMENSIONS IN MILLIMETERS					SEALEXCEL PART NO.
		D1	L1	L2	L3	A/F	
4 mm	1/8 BSPT	9.8	16.4	17.3	8.5	11.1	PIFTME-4-125RT
4 mm	1/4 BSPT	9.8	18.0	23.5	12.5	14.2	PIFTME-4-250RT
6 mm	1/8 BSPT	12.5	20.6	18.0	8.5	12.7	PIFTME-6-125RT
6 mm	1/4 BSPT	12.5	21.4	23.5	12.5	14.2	PIFTME-6-250RT
8 mm	1/8 BSPT	14.2	21.4	19.5	8.5	14.2	PIFTME-8-125RT
8 mm	1/4 BSPT	14.2	21.4	23.5	12.5	14.2	PIFTME-8-250RT
8 mm	3/8 BSPT	14.2	24.6	25.2	12.5	17.4	PIFTME-8-375-RT
10 mm	1/4 BSPT	16.4	24.6	25.2	12.5	17.4	PIFTME-10-250RT
10 mm	3/8 BSPT	16.4	24.6	25.2	12.5	17.4	PIFTME-10-375RT
12 mm	1/4 BSPT	19.0	25.6	26.9	12.5	20.6	PIFTME-12-250RT
12 mm	3/8 BSPT	19.0	25.6	26.9	12.5	20.6	PIFTME-12-375RT
12 mm	1/2 BSPT	19.0	25.6	30.9	16.5	20.6	PIFTME-12-500RT
14 mm	3/8 BSPT	21.8	27.5	28.5	12.5	22.2	PIFTME-14-375RT
14 mm	1/2 BSPT	21.8	27.5	32.5	16.5	22.2	PIFTME-14-500RT
16 mm	1/2 BSPT	23.7	29.0	33.5	16.5	24.0	PIFTME-16-500RT

Note : Metric Tube to male NPT are available on request.

FRACTIONAL Tube to male NPT

TUBE OD	P-PIPE THREAD	DIMENSIONS IN INCHES					SEALEXCEL PART NO.
		D1	L1	L2	L3	A/F	
3/16	1/8 NPT	0.415	0.645	0.680	0.335	7/16	PIFTME-187-125N
3/16	1/4 NPT	0.415	0.710	0.925	0.490	9/16	PIFTME-187-250N
1/4	1/8 NPT	0.495	0.810	0.710	0.335	1/2	PIFTME-250-125N
1/4	1/4 NPT	0.495	0.840	0.925	0.490	9/16	PIFTME-250-250N
5/16	1/8 NPT	0.560	0.840	0.765	0.335	9/16	PIFTME-312-125N
5/16	1/4 NPT	0.560	0.840	0.925	0.490	9/16	PIFTME-312-250N
5/16	3/8 NPT	0.560	0.970	0.990	0.490	11/16	PIFTME-312-375N
3/8	1/4 NPT	0.620	0.970	0.990	0.490	11/16	PIFTME-375-250N
3/8	3/8 NPT	0.620	0.970	0.990	0.490	11/16	PIFTME-375-375N
1/2	1/4 NPT	0.780	1.005	1.060	0.490	13/16	PIFTME-500-250N
1/2	3/8 NPT	0.780	1.005	1.060	0.490	13/16	PIFTME-500-375N
1/2	1/2 NPT	0.780	1.005	1.220	0.650	13/16	PIFTME-500-500N
5/8	1/2 NPT	0.935	1.140	1.320	0.650	15/16	PIFTME-625-500N

Dimensions are for reference only, subject to change without notice

PIF - Taper male branch tee (PIFTMBT)

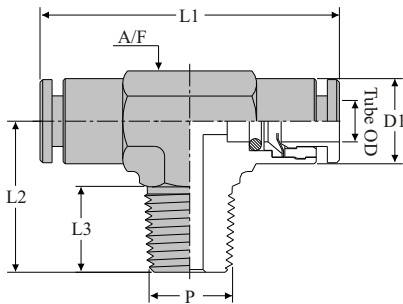

METRIC Tube to male BSPT

TUBE OD	P-PIPE THREAD	DIMENSIONS IN MILLIMETERS					SEALEXCEL PART NO.
		D1	L1	L2	L3	A/F	
4 mm	1/8 BSPT	9.8	32.8	17.3	8.5	11.1	PIFTMBT-4-125RT
4 mm	1/4 BSPT	9.8	36.0	23.5	12.5	14.2	PIFTMBT-4-250RT
6 mm	1/8 BSPT	12.5	41.2	18.0	8.5	12.7	PIFTMBT-6-125RT
6 mm	1/4 BSPT	12.5	42.8	23.5	12.5	14.2	PIFTMBT-6-250RT
8 mm	1/8 BSPT	14.2	42.8	19.5	8.5	14.2	PIFTMBT-8-125RT
8 mm	1/4 BSPT	14.2	42.8	23.5	12.5	14.2	PIFTMBT-8-250RT
8 mm	3/8 BSPT	14.2	49.2	25.2	12.5	17.4	PIFTMBT-8-375RT
10 mm	1/4 BSPT	16.4	49.2	25.2	12.5	17.4	PIFTMBT-10-250RT
10 mm	3/8 BSPT	16.4	49.2	25.2	12.5	17.4	PIFTMBT-10-375RT
12 mm	1/4 BSPT	19.0	51.2	26.9	12.5	20.6	PIFTMBT-12-250RT
12 mm	3/8 BSPT	19.0	51.2	26.9	12.5	20.6	PIFTMBT-12-375RT
12 mm	1/2 BSPT	19.0	51.2	30.9	16.5	20.6	PIFTMBT-12-500RT
14 mm	3/8 BSPT	21.8	55.0	28.5	12.5	22.2	PIFTMBT-14-375RT
14 mm	1/2 BSPT	21.8	55.0	32.5	16.5	22.2	PIFTMBT-14-500RT
16 mm	1/2 BSPT	23.7	58.0	33.5	16.5	24.0	PIFTMBT-16-500RT

Note : Metric Tube to male NPT are available on request.

FRACTIONAL Tube to male NPT

TUBE OD	P-PIPE THREAD	DIMENSIONS IN INCHES					SEALEXCEL PART NO.
		D1	L1	L2	L3	A/F	
3/16	1/8 NPT	0.415	1.290	0.680	0.335	7/16	PIFTMBT-187-125N
3/16	1/4 NPT	0.415	1.420	0.925	0.490	9/16	PIFTMBT-187-250N
1/4	1/8 NPT	0.495	1.620	0.710	0.335	1/2	PIFTMBT-250-125N
1/4	1/4 NPT	0.495	1.685	0.925	0.490	9/16	PIFTMBT-250-250N
5/16	1/8 NPT	0.560	1.685	0.765	0.335	9/16	PIFTMBT-312-125N
5/16	1/4 NPT	0.560	1.685	0.925	0.490	9/16	PIFTMBT-312-250N
5/16	3/8 NPT	0.560	1.935	0.990	0.490	11/16	PIFTMBT-312-375N
3/8	1/4 NPT	0.620	1.935	0.990	0.490	11/16	PIFTMBT-375-250N
3/8	3/8 NPT	0.620	1.935	0.990	0.490	11/16	PIFTMBT-375-375N
1/2	1/4 NPT	0.780	2.015	1.060	0.490	13/16	PIFTMBT-500-250N
1/2	3/8 NPT	0.780	2.015	1.060	0.490	13/16	PIFTMBT-500-375N
1/2	1/2 NPT	0.780	2.015	1.220	0.650	13/16	PIFTMBT-500-500N
5/8	1/2 NPT	0.935	2.285	1.320	0.650	15/16	PIFTMBT-625-500N

Dimensions are for reference only, subject to change without notice

PIF - Taper male run tee (PIFTMRT)

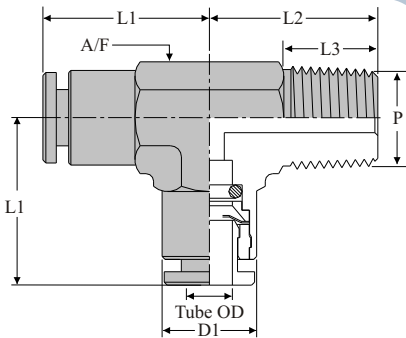

METRIC Tube to male BSPT

TUBE OD	P-PIPE THREAD	DIMENSIONS IN MILLIMETERS					SEALEXCEL PART NO.
		D1	L1	L2	L3	A/F	
4 mm	1/8 BSPT	9.8	16.4	17.3	8.5	11.1	PIFTMRT-4-125RT
4 mm	1/4 BSPT	9.8	18.0	23.5	12.5	14.2	PIFTMRT-4-250RT
6 mm	1/8 BSPT	12.5	20.6	18.0	8.5	12.7	PIFTMRT-6-125RT
6 mm	1/4 BSPT	12.5	21.4	23.5	12.5	14.2	PIFTMRT-6-250RT
8 mm	1/8 BSPT	14.2	21.4	19.5	8.5	14.2	PIFTMRT-8-125RT
8 mm	1/4 BSPT	14.2	21.4	23.5	12.5	14.2	PIFTMRT-8-250RT
8 mm	3/8 BSPT	14.2	24.6	25.2	12.5	17.4	PIFTMRT-8-375-RT
10 mm	1/4 BSPT	16.4	24.6	25.2	12.5	17.4	PIFTMRT-10-250RT
10 mm	3/8 BSPT	16.4	24.6	25.2	12.5	17.4	PIFTMRT-10-375RT
12 mm	1/4 BSPT	19.0	25.6	26.9	12.5	20.6	PIFTMRT-12-250RT
12 mm	3/8 BSPT	19.0	25.6	26.9	12.5	20.6	PIFTMRT-12-375RT
12 mm	1/2 BSPT	19.0	25.6	30.9	16.5	20.6	PIFTMRT-12-500RT
14 mm	3/8 BSPT	21.8	27.5	28.5	12.5	22.2	PIFTMRT-14-375RT
14 mm	1/2 BSPT	21.8	27.5	32.5	16.5	22.2	PIFTMRT-14-500RT
16 mm	1/2 BSPT	23.7	29.0	33.5	16.5	24.0	PIFTMRT-16-500RT

Note : Metric Tube to male NPT are available on request.

FRACTIONAL Tube to male NPT

TUBE OD	P-PIPE THREAD	DIMENSIONS IN INCHES					SEALEXCEL PART NO.
		D1	L1	L2	L3	A/F	
3/16	1/8 NPT	0.415	0.645	0.680	0.335	7/16	PIFTMRT-187-125N
3/16	1/4 NPT	0.415	0.710	0.925	0.490	9/16	PIFTMRT-187-250N
1/4	1/8 NPT	0.495	0.810	0.710	0.335	1/2	PIFTMRT-250-125N
1/4	1/4 NPT	0.495	0.840	0.925	0.490	9/16	PIFTMRT-250-250N
5/16	1/8 NPT	0.560	0.840	0.765	0.335	9/16	PIFTMRT-312-125N
5/16	1/4 NPT	0.560	0.840	0.925	0.490	9/16	PIFTMRT-312-250N
5/16	3/8 NPT	0.560	0.970	0.990	0.490	11/16	PIFTMRT-312-375N
3/8	1/4 NPT	0.620	0.970	0.990	0.490	11/16	PIFTMRT-375-250N
3/8	3/8 NPT	0.620	0.970	0.990	0.490	11/16	PIFTMRT-375-375N
1/2	1/4 NPT	0.780	1.005	1.060	0.490	13/16	PIFTMRT-500-250N
1/2	3/8 NPT	0.780	1.005	1.060	0.490	13/16	PIFTMRT-500-375N
1/2	1/2 NPT	0.780	1.005	1.220	0.650	13/16	PIFTMRT-500-500N
5/8	1/2 NPT	0.935	1.140	1.320	0.650	15/16	PIFTMRT-625-500N

Dimensions are for reference only, subject to change without notice

PIF - Taper male swivel elbow (PIFTMSE)

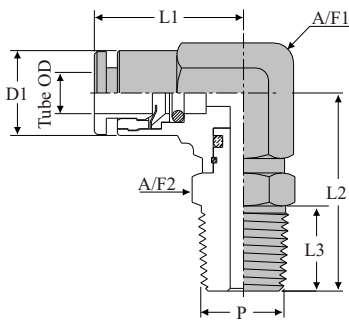

METRIC Tube to male BSPT

TUBE OD	P-PIPE THREAD	DIMENSIONS IN MILLIMETERS						SEALEXCEL PART NO.
		D1	L1	L2	L3	A/F1	A/F2	
4 mm	1/8 BSPT	9.8	17.1	26.7	8.5	11.1	11.1	PIFTMSE-4-125RT
4 mm	1/4 BSPT	9.8	17.1	29.8	12.5	11.1	14.2	PIFTMSE-4-250RT
6 mm	1/8 BSPT	12.5	20.6	27.7	8.5	12.7	12.7	PIFTMSE-6-125RT
6 mm	1/4 BSPT	12.5	20.6	30.7	12.5	12.7	14.2	PIFTMSE-6-250RT
8 mm	1/8 BSPT	14.2	21.4	28.7	8.5	14.2	14.2	PIFTMSE-8-125RT
8 mm	1/4 BSPT	14.2	21.4	32.7	12.5	14.2	14.2	PIFTMSE-8-250RT
8 mm	3/8 BSPT	14.2	21.4	32.7	12.5	14.2	17.4	PIFTMSE-8-375RT
10 mm	1/4 BSPT	16.4	24.6	33.9	12.5	17.4	17.4	PIFTMSE-10-250RT
10 mm	3/8 BSPT	16.4	24.6	34.1	12.5	17.4	17.4	PIFTMSE-10-375RT
12 mm	1/4 BSPT	19.0	25.6	37.3	12.5	20.6	20.6	PIFTMSE-12-250RT
12 mm	3/8 BSPT	19.0	25.6	37.3	12.5	20.6	20.6	PIFTMSE-12-375RT
12 mm	1/2 BSPT	19.0	25.6	39.8	16.5	20.6	22.2	PIFTMSE-12-500RT
14 mm	3/8 BSPT	21.8	27.5	38.5	12.5	22.2	22.2	PIFTMSE-14-375RT
14 mm	1/2 BSPT	21.8	27.5	42.6	16.5	22.2	22.2	PIFTMSE-14-500RT
16 mm	1/2 BSPT	23.7	29.0	44.0	16.5	24.0	24.0	PIFTMSE-16-500RT

Note : Metric Tube to male NPT are available on request.

FRACTIONAL Tube to male NPT

TUBE OD	P-PIPE THREAD	DIMENSIONS IN INCHES						SEALEXCEL PART NO.
		D1	L1	L2	L3	A/F1	A/F2	
3/16	1/8 NPT	0.415	0.675	1.050	0.335	7/16	7/16	PIFTMSE-187-125N
3/16	1/4 NPT	0.415	0.675	1.175	0.490	7/16	9/16	PIFTMSE-187-250N
1/4	1/8 NPT	0.495	0.810	1.090	0.335	1/2	1/2	PIFTMSE-250-125N
1/4	1/4 NPT	0.495	0.810	1.230	0.490	1/2	9/16	PIFTMSE-250-250N
5/16	1/8 NPT	0.560	0.840	1.130	0.335	9/16	9/16	PIFTMSE-312-125N
5/16	1/4 NPT	0.560	0.840	1.285	0.490	9/16	9/16	PIFTMSE-312-250N
5/16	3/8 NPT	0.560	0.840	1.285	0.490	9/16	11/16	PIFTMSE-312-375N
3/8	1/4 NPT	0.620	0.970	1.335	0.490	11/16	11/16	PIFTMSE-375-250N
3/8	3/8 NPT	0.620	0.970	1.340	0.490	11/16	11/16	PIFTMSE-375-375N
1/2	1/4 NPT	0.780	1.005	1.470	0.490	13/16	13/16	PIFTMSE-500-250N
1/2	3/8 NPT	0.780	1.005	1.470	0.490	13/16	13/16	PIFTMSE-500-375N
1/2	1/2 NPT	0.780	1.005	1.565	0.650	13/16	7/8	PIFTMSE-500-500N
5/8	1/2 NPT	0.935	1.140	1.730	0.650	15/16	15/16	PIFTMSE-625-500N

Dimensions are for reference only, subject to change without notice

PIF - Taper male swivel branch tee (PIFTMSBT)

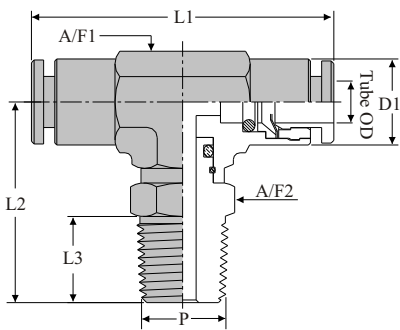

METRIC Tube to male BSPT

TUBE OD	P-PIPE THREAD	DIMENSIONS IN MILLIMETERS						SEALEXCEL PART NO.
		D1	L1	L2	L3	A/F1	A/F2	
4 mm	1/8 BSPT	9.8	34.2	26.7	8.5	11.1	11.1	PIFTMSBT-4-125RT
4 mm	1/4 BSPT	9.8	34.2	29.8	12.5	11.1	14.2	PIFTMSBT-4-250RT
6 mm	1/8 BSPT	12.5	41.2	27.7	8.5	12.7	12.7	PIFTMSBT-6-125RT
6 mm	1/4 BSPT	12.5	41.2	30.7	12.5	12.7	14.2	PIFTMSBT-6-250RT
8 mm	1/8 BSPT	14.2	42.8	28.7	8.5	14.2	14.2	PIFTMSBT-8-125RT
8 mm	1/4 BSPT	14.2	42.8	32.7	12.5	14.2	14.2	PIFTMSBT-8-250RT
8 mm	3/8 BSPT	14.2	42.8	32.7	12.5	14.2	17.4	PIFTMSBT-8-375RT
10 mm	1/4 BSPT	16.4	49.2	33.9	12.5	17.4	17.4	PIFTMSBT-10-250RT
10 mm	3/8 BSPT	16.4	49.2	34.1	12.5	17.4	17.4	PIFTMSBT-10-375RT
12 mm	1/4 BSPT	19.0	51.2	37.3	12.5	20.6	20.6	PIFTMSBT-12-250RT
12 mm	3/8 BSPT	19.0	51.2	37.3	12.5	20.6	20.6	PIFTMSBT-12-375RT
12 mm	1/2 BSPT	19.0	51.2	39.8	16.5	20.6	22.2	PIFTMSBT-12-500RT
14 mm	3/8 BSPT	21.8	55.0	38.5	12.5	22.2	22.2	PIFTMSBT-14-375RT
14 mm	1/2 BSPT	21.8	55.0	42.6	16.5	22.2	22.2	PIFTMSBT-14-500RT
16 mm	1/2 BSPT	23.7	58.0	44.0	16.5	24.0	24.0	PIFTMSBT-16-500RT

Note : Metric Tube to male NPT are available on request.

FRACTIONAL Tube to male NPT

TUBE OD	P-PIPE THREAD	DIMENSIONS IN INCHES						SEALEXCEL PART NO.
		D1	L1	L2	L3	A/F1	A/F2	
3/16	1/8 NPT	0.415	1.345	1.050	0.335	7/16	7/16	PIFTMSBT-187-125N
3/16	1/4 NPT	0.415	1.345	1.175	0.490	7/16	9/16	PIFTMSBT-187-250N
1/4	1/8 NPT	0.495	1.620	1.090	0.335	1/2	1/2	PIFTMSBT-250-125N
1/4	1/4 NPT	0.495	1.620	1.230	0.490	1/2	9/16	PIFTMSBT-250-250N
5/16	1/8 NPT	0.560	1.685	1.130	0.335	9/16	9/16	PIFTMSBT-312-125N
5/16	1/4 NPT	0.560	1.685	1.285	0.490	9/16	9/16	PIFTMSBT-312-250N
5/16	3/8 NPT	0.560	1.685	1.285	0.490	9/16	11/16	PIFTMSBT-312-375N
3/8	1/4 NPT	0.620	1.935	1.335	0.490	11/16	11/16	PIFTMSBT-375-250N
3/8	3/8 NPT	0.620	1.935	1.340	0.490	11/16	11/16	PIFTMSBT-375-375N
1/2	1/4 NPT	0.780	2.015	1.470	0.490	13/16	13/16	PIFTMSBT-500-250N
1/2	3/8 NPT	0.780	2.015	1.470	0.490	13/16	13/16	PIFTMSBT-500-375N
1/2	1/2 NPT	0.780	2.015	1.565	0.650	13/16	7/8	PIFTMSBT-500-500N
5/8	1/2 NPT	0.935	2.285	1.730	0.650	15/16	15/16	PIFTMSBT-625-500N

Dimensions are for reference only, subject to change without notice

PIF - Taper male swivel run tee (PIFTMSRT)

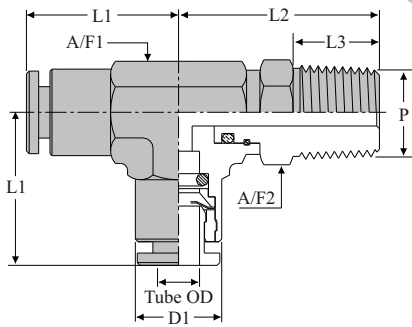

METRIC Tube to male BSPT

TUBE OD	P-PIPE THREAD	DIMENSIONS IN MILLIMETERS						SEALEXCEL PART NO.
		D1	L1	L2	L3	A/F1	A/F2	
4 mm	1/8 BSPT	9.8	17.1	26.7	8.5	11.1	11.1	PIFTMSRT-4-125RT
4 mm	1/4 BSPT	9.8	17.1	29.8	12.5	11.1	14.2	PIFTMSRT-4-250RT
6 mm	1/8 BSPT	12.5	20.6	27.7	8.5	12.7	12.7	PIFTMSRT-6-125RT
6 mm	1/4 BSPT	12.5	20.6	30.7	12.5	12.7	14.2	PIFTMSRT-6-250RT
8 mm	1/8 BSPT	14.2	21.4	28.7	8.5	14.2	14.2	PIFTMSRT-8-125RT
8 mm	1/4 BSPT	14.2	21.4	32.7	12.5	14.2	14.2	PIFTMSRT-8-250RT
8 mm	3/8 BSPT	14.2	21.4	32.7	12.5	14.2	17.4	PIFTMSRT-8-375RT
10 mm	1/4 BSPT	16.4	24.6	33.9	12.5	17.4	17.4	PIFTMSRT-10-250RT
10 mm	3/8 BSPT	16.4	24.6	34.1	12.5	17.4	17.4	PIFTMSRT-10-375RT
12 mm	1/4 BSPT	19.0	25.6	37.3	12.5	20.6	20.6	PIFTMSRT-12-250RT
12 mm	3/8 BSPT	19.0	25.6	37.3	12.5	20.6	20.6	PIFTMSRT-12-375RT
12 mm	1/2 BSPT	19.0	25.6	39.8	16.5	20.6	22.2	PIFTMSRT-12-500RT
14 mm	3/8 BSPT	21.8	27.5	38.5	12.5	22.2	22.2	PIFTMSRT-14-375RT
14 mm	1/2 BSPT	21.8	27.5	42.6	16.5	22.2	22.2	PIFTMSRT-14-500RT
16 mm	1/2 BSPT	23.7	29.0	44.0	16.5	24.0	24.0	PIFTMSRT-16-500RT

Note : Metric Tube to male NPT are available on request.

FRACTIONAL Tube to male NPT

TUBE OD	P-PIPE THREAD	DIMENSIONS IN INCHES						SEALEXCEL PART NO.
		D1	L1	L2	L3	A/F1	A/F2	
3/16	1/8 NPT	0.415	0.675	1.050	0.335	7/16	7/16	PIFTMSRT-187-125N
3/16	1/4 NPT	0.415	0.675	1.175	0.490	7/16	9/16	PIFTMSRT-187-250N
1/4	1/8 NPT	0.495	0.810	1.090	0.335	1/2	1/2	PIFTMSRT-250-125N
1/4	1/4 NPT	0.495	0.810	1.230	0.490	1/2	9/16	PIFTMSRT-250-250N
5/16	1/8 NPT	0.560	0.840	1.130	0.335	9/16	9/16	PIFTMSRT-312-125N
5/16	1/4 NPT	0.560	0.840	1.285	0.490	9/16	9/16	PIFTMSRT-312-250N
5/16	3/8 NPT	0.560	0.840	1.285	0.490	9/16	11/16	PIFTMSRT-312-375N
3/8	1/4 NPT	0.620	0.970	1.335	0.490	11/16	11/16	PIFTMSRT-375-250N
3/8	3/8 NPT	0.620	0.970	1.340	0.490	11/16	11/16	PIFTMSRT-375-375N
1/2	1/4 NPT	0.780	1.005	1.470	0.490	13/16	13/16	PIFTMSRT-500-250N
1/2	3/8 NPT	0.780	1.005	1.470	0.490	13/16	13/16	PIFTMSRT-500-375N
1/2	1/2 NPT	0.780	1.005	1.565	0.650	13/16	7/8	PIFTMSRT-500-500N
5/8	1/2 NPT	0.935	1.140	1.730	0.650	15/16	15/16	PIFTMSRT-625-500N

Dimensions are for reference only, subject to change without notice

PIF - Parallel male connector (PIFPMC)

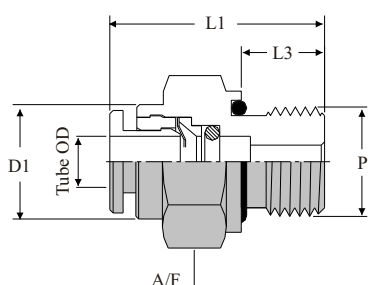

METRIC Tube to male BSP

TUBE OD	P-PIPE THREAD	DIMENSIONS IN MILLIMETERS				SEALEXCEL PART NO.
		D1	L1	L3	A/F	
4 mm	M5	9.8	24.4	7.5	11.1	PIFPMC-4-5MEO
4 mm	1/8 BSP	9.8	22.6	8.0	14.2	PIFPMC-4-125EO
4 mm	1/4 BSP	9.8	24.1	10.0	17.4	PIFPMC-4-250EO
6 mm	1/8 BSP	12.5	24.6	8.0	14.2	PIFPMC-6-125EO
6 mm	1/4 BSP	12.5	24.6	10.0	17.4	PIFPMC-6-250EO
8 mm	1/8 BSP	14.2	27.6	8.0	14.2	PIFPMC-8-125EO
8 mm	1/4 BSP	14.2	26.6	10.0	17.4	PIFPMC-8-250EO
8 mm	3/8 BSP	14.2	26.7	10.0	20.6	PIFPMC-8-375EO
10 mm	1/4 BSP	16.4	29.6	10.0	17.4	PIFPMC-10-250EO
10 mm	3/8 BSP	16.4	26.8	10.0	20.6	PIFPMC-10-375EO
12 mm	1/4 BSP	19.0	31.0	10.0	20.6	PIFPMC-12-250EO
12 mm	3/8 BSP	19.0	31.0	10.0	20.6	PIFPMC-12-375EO
12 mm	1/2 BSP	19.0	30.5	12.0	27.0	PIFPMC-12-500EO
14 mm	3/8 BSP	21.8	32.5	10.0	22.2	PIFPMC-14-375EO
14 mm	1/2 BSP	21.8	31.5	12.0	27.0	PIFPMC-14-500EO
16 mm	1/2 BSP	23.7	35.0	12.0	27.0	PIFPMC-16-500EO

PIF - Parallel male swivel elbow (PIFPMSE)

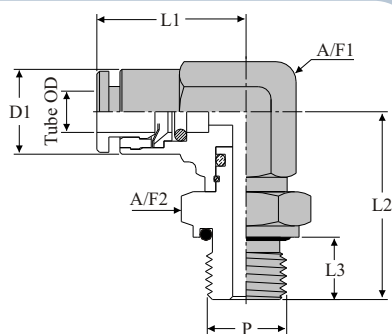

METRIC Tube to male BSP

TUBE OD	P-PIPE THREAD	DIMENSIONS IN MILLIMETERS						SEALEXCEL PART NO.
		D1	L1	L2	L3	A/F1	A/F2	
4 mm	M5	9.8	17.1	26.5	7.5	11.1	11.1	PIFPMSE-4-5MEO
4 mm	1/8 BSP	9.8	17.1	26.9	8.0	11.1	14.2	PIFPMSE-4-125EO
4 mm	1/4 BSP	9.8	17.1	28.9	10.0	11.1	17.4	PIFPMSE-4-250EO
6 mm	1/8 BSP	12.5	20.6	27.8	8.0	12.7	14.2	PIFPMSE-6-125EO
6 mm	1/4 BSP	12.5	20.6	30.0	10.0	12.7	17.4	PIFPMSE-6-250EO
8 mm	1/8 BSP	14.2	21.4	29.8	8.0	14.2	14.2	PIFPMSE-8-125EO
8 mm	1/4 BSP	14.2	21.4	32.0	10.0	14.2	17.4	PIFPMSE-8-250EO
8 mm	3/8 BSP	14.2	21.4	32.0	10.0	14.2	20.6	PIFPMSE-8-375EO
10 mm	1/4 BSP	16.4	24.6	33.1	10.0	17.4	17.4	PIFPMSE-10-250EO
10 mm	3/8 BSP	16.4	24.6	33.1	10.0	17.4	20.6	PIFPMSE-10-375EO
12 mm	1/4 BSP	19.0	25.6	35.3	10.0	20.6	19.0	PIFPMSE-12-250EO
12 mm	3/8 BSP	19.0	25.6	35.8	10.0	20.6	20.6	PIFPMSE-12-375EO
12 mm	1/2 BSP	19.0	25.6	38.8	12.0	20.6	27.0	PIFPMSE-12-500EO
14 mm	3/8 BSP	21.8	27.5	38.0	10.0	22.2	22.2	PIFPMSE-14-375EO
14 mm	1/2 BSP	21.8	27.5	40.8	12.0	22.2	27.0	PIFPMSE-14-500EO
16 mm	1/2 BSP	23.7	29.0	42.0	12.0	24.0	27.0	PIFPMSE-16-500EO

Dimensions are for reference only, subject to change without notice

PIF - Parallel male swivel branch tee (PIFPMSBT)

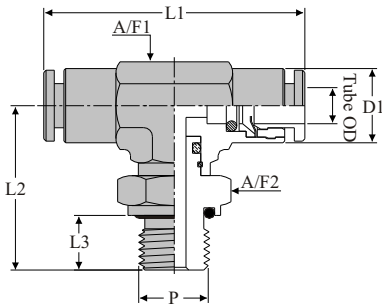

METRIC Tube to male BSP

TUBE OD	P-PIPE THREAD	DIMENSIONS IN MILLIMETERS						SEALEXCEL PART NO.
		D1	L1	L2	L3	A/F1	A/F2	
4 mm	M5	9.8	34.2	26.5	7.5	11.1	11.1	PIFPMSBT-4-5ME0
4 mm	1/8 BSP	9.8	34.2	26.9	8.0	11.1	14.2	PIFPMSBT-4-125E0
4 mm	1/4 BSP	9.8	34.2	28.9	10.0	11.1	17.4	PIFPMSBT-4-250E0
6 mm	1/8 BSP	12.5	41.2	27.8	8.0	12.7	14.2	PIFPMSBT-6-125E0
6 mm	1/4 BSP	12.5	41.2	30.0	10.0	12.7	17.4	PIFPMSBT-6-250E0
8 mm	1/8 BSP	14.2	42.8	29.8	8.0	14.2	14.2	PIFPMSBT-8-125E0
8 mm	1/4 BSP	14.2	42.8	32.0	10.0	14.2	17.4	PIFPMSBT-8-250E0
8 mm	3/8 BSP	14.2	42.8	32.0	10.0	14.2	20.6	PIFPMSBT-8-375E0
10 mm	1/4 BSP	16.4	49.2	33.1	10.0	17.4	17.4	PIFPMSBT-10-250E0
10 mm	3/8 BSP	16.4	49.2	33.1	10.0	17.4	20.6	PIFPMSBT-10-375E0
12 mm	1/4 BSP	19.0	51.2	35.3	10.0	20.6	19.0	PIFPMSBT-12-250E0
12 mm	3/8 BSP	19.0	51.2	35.8	10.0	20.6	20.6	PIFPMSBT-12-375E0
12 mm	1/2 BSP	19.0	51.2	38.8	12.0	20.6	27.0	PIFPMSBT-12-500E0
14 mm	3/8 BSP	21.8	55.0	38.0	10.0	22.2	22.2	PIFPMSBT-14-375E0
14 mm	1/2 BSP	21.8	55.0	40.8	12.0	22.2	27.0	PIFPMSBT-14-500E0
16 mm	1/2 BSP	23.7	58.0	42.0	12.0	24.0	27.0	PIFPMSBT-16-500E0

PIF - Parallel male swivel run tee (PIFPMSRT)

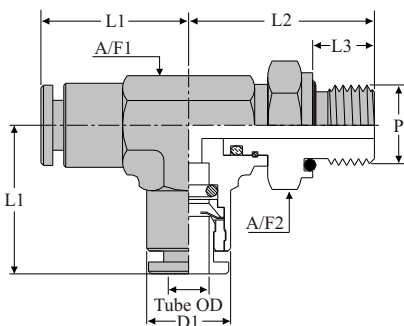

METRIC Tube to male BSP

TUBE OD	P-PIPE THREAD	DIMENSIONS IN MILLIMETERS						SEALEXCEL PART NO.
		D1	L1	L2	L3	A/F1	A/F2	
4 mm	M5	9.8	17.1	26.5	7.5	11.1	11.1	PIFPMSRT-4-5ME0
4 mm	1/8 BSP	9.8	17.1	26.9	8.0	11.1	14.2	PIFPMSRT-4-125E0
4 mm	1/4 BSP	9.8	17.1	28.9	10.0	11.1	17.4	PIFPMSRT-4-250E0
6 mm	1/8 BSP	12.5	20.6	27.8	8.0	12.7	14.2	PIFPMSRT-6-125E0
6 mm	1/4 BSP	12.5	20.6	30.0	10.0	12.7	17.4	PIFPMSRT-6-250E0
8 mm	1/8 BSP	14.2	21.4	29.8	8.0	14.2	14.2	PIFPMSRT-8-125E0
8 mm	1/4 BSP	14.2	21.4	32.0	10.0	14.2	17.4	PIFPMSRT-8-250E0
8 mm	3/8 BSP	14.2	21.4	32.0	10.0	14.2	20.6	PIFPMSRT-8-375E0
10 mm	1/4 BSP	16.4	24.6	33.1	10.0	17.4	17.4	PIFPMSRT-10-250E0
10 mm	3/8 BSP	16.4	24.6	33.1	10.0	17.4	20.6	PIFPMSRT-10-375E0
12 mm	1/4 BSP	19.0	25.6	35.3	10.0	20.6	19.0	PIFPMSRT-12-250E0
12 mm	3/8 BSP	19.0	25.6	35.8	10.0	20.6	20.6	PIFPMSRT-12-375E0
12 mm	1/2 BSP	19.0	25.6	38.8	12.0	20.6	27.0	PIFPMSRT-12-500E0
14 mm	3/8 BSP	21.8	27.5	38.0	10.0	22.2	22.2	PIFPMSRT-14-375E0
14 mm	1/2 BSP	21.8	27.5	40.8	12.0	22.2	27.0	PIFPMSRT-14-500E0
16 mm	1/2 BSP	23.7	29.0	42.0	12.0	24.0	27.0	PIFPMSRT-16-500E0

Dimensions are for reference only, subject to change without notice

PIF - Union (PIFU)

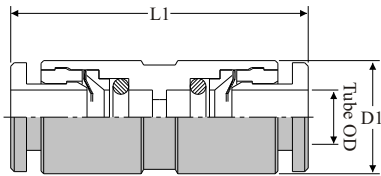

METRIC Tube to Tube

TUBE OD	DIMENSIONS IN MILLIMETERS		SEALEXCEL PART NO.
	D1	L1	
4 mm	9.8	29.2	PIFU-4
6 mm	12.5	34.6	PIFU-6
8 mm	14.2	34.6	PIFU-8
10 mm	16.4	35.7	PIFU-10
12 mm	19.0	37.8	PIFU-12
14 mm	21.8	40.8	PIFU-14
16 mm	23.7	40.8	PIFU-16

FRACTIONAL Tube to Tube

TUBE OD	DIMENSIONS IN INCHES		SEALEXCEL PART NO.
	D1	L1	
3/16	0.415	1.150	PIFU-187
1/4	0.495	1.370	PIFU-250
5/16	0.560	1.370	PIFU-312
3/8	0.625	1.395	PIFU-375
1/2	0.780	1.490	PIFU-500
5/8	0.935	1.605	PIFU-625

PIF - Union elbow (PIFUE)

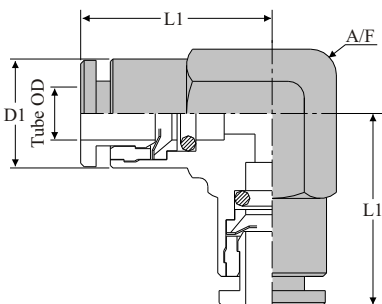

METRIC Tube to Tube

TUBE OD	DIMENSIONS IN MILLIMETERS			SEALEXCEL PART NO.
	D1	L1	A/F	
4 mm	9.8	16.4	11.1	PIFUE-4
6 mm	12.5	20.6	12.7	PIFUE-6
8 mm	14.2	21.4	14.2	PIFUE-8
10 mm	16.4	24.6	17.4	PIFUE-10
12 mm	19.0	25.6	20.6	PIFUE-12
14 mm	21.8	27.5	22.2	PIFUE-14
16 mm	23.7	29.0	24.0	PIFUE-16

FRACTIONAL Tube to Tube

TUBE OD	DIMENSIONS IN INCHES			SEALEXCEL PART NO.
	D1	L1	A/F	
3/16	0.415	0.645	7/16	PIFUE-187
1/4	0.495	0.810	1/2	PIFUE-250
5/16	0.560	0.840	9/16	PIFUE-312
3/8	0.635	0.970	11/16	PIFUE-375
1/2	0.780	1.005	13/16	PIFUE-500
5/8	0.935	1.140	15/16	PIFUE-625

Dimensions are for reference only, subject to change without notice

PIF - Bulkhead union (PIFBU)



METRIC Tube to Tube

TUBE OD	DIMENSIONS IN MILLIMETERS					SEALEXCEL PART NO.
	D1	L1	G	A/F	H	
4 mm	9.8	32.7	6.0	14.2	M11x0.75	PIFBU-4
6 mm	12.5	35.7	6.0	19.0	M13x1	PIFBU-6
8 mm	14.2	36.7	6.0	20.6	M16x1.25	PIFBU-8
10 mm	16.4	43.2	8.0	22.2	M18x1	PIFBU-10
12 mm	19.0	46.8	10.0	27.0	M22x1.5	PIFBU-12

FRACTIONAL Tube to Tube

TUBE OD	DIMENSIONS IN INCHES					SEALEXCEL PART NO.
	D1	L1	G	A/F	H	
3/16	0.415	1.285	0.235	9/16	7/16x28 UN	PIFBU-187
1/4	0.495	1.405	0.235	3/4	9/16x20 UN	PIFBU-250
5/16	0.560	1.445	0.235	13/16	5/8x20 UN	PIFBU-312
3/8	0.620	1.700	0.315	7/8	3/4x20 UN	PIFBU-375
1/2	0.780	1.840	0.395	1-1/16	7/8x20 UN	PIFBU-500

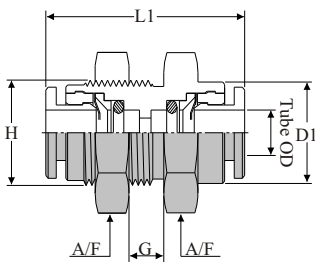

PIF - Union tee (PIFUT)



METRIC Tube to Tube

TUBE OD	DIMENSIONS IN MILLIMETERS				SEALEXCEL PART NO.
	D1	L1	L2	A/F	
4 mm	9.8	32.8	16.4	11.1	PIFUT-4
6 mm	12.5	41.2	20.6	12.7	PIFUT-6
8 mm	14.2	42.8	21.4	14.2	PIFUT-8
10 mm	16.4	49.2	24.6	17.4	PIFUT-10
12 mm	19.0	51.2	25.6	20.6	PIFUT-12
14 mm	21.8	55.0	27.5	22.2	PIFUT-14
16 mm	23.7	58.0	29.0	24.0	PIFUT-16

FRACTIONAL Tube to Tube

TUBE OD	DIMENSIONS IN INCHES				SEALEXCEL PART NO.
	D1	L1	L2	A/F	
3/16	0.415	1.290	0.645	7/16	PIFUT-187
1/4	0.495	1.620	0.810	1/2	PIFUT-250
5/16	0.560	1.685	0.840	9/16	PIFUT-312
3/8	0.635	1.935	0.970	11/16	PIFUT-375
1/2	0.780	2.015	1.005	13/16	PIFUT-500
5/8	0.935	2.285	1.140	15/16	PIFUT-625

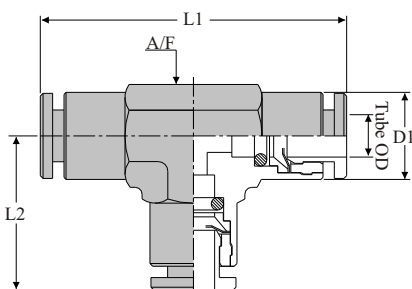

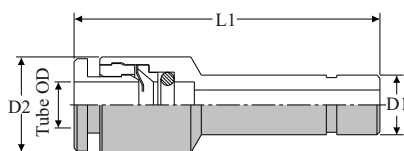

METRIC Tube to Tube

TUBE OD	DIMENSIONS IN MILLIMETERS			SEALEXCEL PART NO.
	D1	D2	L1	
4 mm	6.0	9.8	35.6	PIFR-4-6
4 mm	8.0	9.8	35.6	PIFR-4-8
6 mm	8.0	12.5	42.1	PIFR-6-8
6 mm	10.0	12.5	43.1	PIFR-6-10
8 mm	10.0	14.2	43.1	PIFR-8-10
8 mm	12.0	14.2	46.1	PIFR-8-12
10 mm	12.0	16.4	46.6	PIFR-10-12
12 mm	14.0	19.0	50.0	PIFR-12-14
12 mm	16.0	19.0	50.0	PIFR-12-16

FRACTIONAL Tube to Tube

TUBE OD	DIMENSIONS IN INCHES			SEALEXCEL PART NO.
	D1	D2	L1	
3/16	0.250	0.415	1.400	PIFR-187-250
3/16	0.312	0.415	1.400	PIFR-187-312
1/4	0.312	0.495	1.655	PIFR-250-312
1/4	0.375	0.495	1.695	PIFR-250-375
5/16	0.375	0.560	1.695	PIFR-312-375
5/16	0.500	0.560	1.815	PIFR-312-500
3/8	0.500	0.620	1.835	PIFR-375-500
1/2	0.625	0.780	1.970	PIFR-500-625

Dimensions are for reference only, subject to change without notice

PIF - Male adapter (PIFMA)

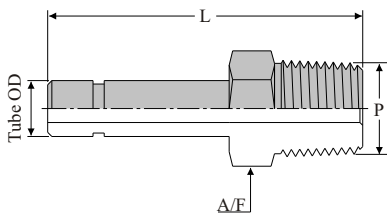

METRIC Tube to male BSPT

TUBE OD	P-PIPE THREAD	DIM. IN MILLIMETERS		SEALEXCEL PART NO.
		L	A/F	
4 mm	1/8 BSPT	35.0	11.1	PIFMA-4-125RT
4 mm	1/4 BSPT	39.0	14.2	PIFMA-4-250RT
6 mm	1/8 BSPT	40.0	11.1	PIFMA-6-125RT
6 mm	1/4 BSPT	44.0	14.2	PIFMA-6-250RT
8 mm	1/8 BSPT	40.0	11.1	PIFMA-8-125RT
8 mm	1/4 BSPT	44.0	14.2	PIFMA-8-250RT
8 mm	3/8 BSPT	44.0	17.4	PIFMA-8-375RT
10 mm	1/4 BSPT	47.5	14.2	PIFMA-10-250RT
10 mm	3/8 BSPT	47.5	17.4	PIFMA-10-375RT
12 mm	1/4 BSPT	49.5	14.2	PIFMA-12-250RT
12 mm	3/8 BSPT	49.5	17.4	PIFMA-12-375RT
12 mm	1/2 BSPT	53.5	22.2	PIFMA-12-500RT
14 mm	3/8 BSPT	49.5	17.4	PIFMA-14-375RT
14 mm	1/2 BSPT	53.5	22.2	PIFMA-14-500RT
16 mm	1/2 BSPT	54.5	22.2	PIFMA-16-500RT

Note : Metric Tube to male NPT are available on request.

FRACTIONAL Tube to male NPT

TUBE OD	P-PIPE THREAD	DIM. IN INCHES		SEALEXCEL PART NO.
		L	A/F	
3/16	1/8 NPT	1.380	7/16	PIFMA-187-125N
3/16	1/4 NPT	1.535	9/16	PIFMA-187-250N
1/4	1/8 NPT	1.575	7/16	PIFMA-250-125N
1/4	1/4 NPT	1.730	9/16	PIFMA-250-250N
5/16	1/8 NPT	1.575	7/16	PIFMA-312-125N
5/16	1/4 NPT	1.730	9/16	PIFMA-312-250N
5/16	3/8 NPT	1.730	11/16	PIFMA-312-375N
3/8	1/4 NPT	1.870	9/16	PIFMA-375-250N
3/8	3/8 NPT	1.870	11/16	PIFMA-375-375N
1/2	1/4 NPT	1.950	9/16	PIFMA-500-250N
1/2	3/8 NPT	1.950	11/16	PIFMA-500-375N
1/2	1/2 NPT	2.105	7/8	PIFMA-500-500N
5/8	1/2 NPT	2.145	7/8	PIFMA-625-500N

Dimensions are for reference only, subject to change without notice

PIF - 'O' Ring male adapter (PIFOMA)

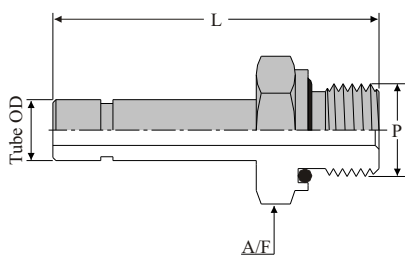

METRIC Tube to male BSP

TUBE OD	P-PIPE THREAD	DIM. IN MILLIMETERS		SEALEXCEL PART NO.
		L	A/F	
4 mm	M5	35.7	11.1	PIFOMA-4-5ME0
4 mm	1/8 BSP	36.2	14.2	PIFOMA-4-125E0
4 mm	1/4 BSP	38.2	17.4	PIFOMA-4-250E0
6 mm	1/8 BSP	41.2	14.2	PIFOMA-6-125E0
6 mm	1/4 BSP	43.2	17.4	PIFOMA-6-250E0
8 mm	1/8 BSP	41.2	14.2	PIFOMA-8-125E0
8 mm	1/4 BSP	43.2	17.4	PIFOMA-8-250E0
8 mm	3/8 BSP	43.2	20.6	PIFOMA-8-375E0
10 mm	1/4 BSP	46.8	17.4	PIFOMA-10-250E0
10 mm	3/8 BSP	46.8	20.6	PIFOMA-10-375E0
12 mm	1/4 BSP	48.8	20.6	PIFOMA-12-250E0
12 mm	3/8 BSP	48.8	20.6	PIFOMA-12-375E0
12 mm	1/2 BSP	50.8	27.0	PIFOMA-12-500E0
14 mm	3/8 BSP	48.8	20.6	PIFOMA-14-375E0
14 mm	1/2 BSP	50.8	27.0	PIFOMA-14-500E0
16 mm	1/2 BSP	51.8	27.0	PIFOMA-16-500E0

Dimensions are for reference only, subject to change without notice

SEALEXCEL



Unit II,
Gujarat,
India.



SEALEXCEL (INDIA) PVT. LTD.

Registered office & Unit I :
61, Veena Dalvai Industrial Estate,
S. V. Road, Oshiwara, Jogeshwari (West),
Mumbai - 400 102. INDIA

Ph. : (+91-22) 2678 6885,
2678 8534,
5694 4124

Fax : (+91-22) 2678 1426,
5694 4126

E-mail : sales@sealexcel.com

Unit II :
Plot no. 300/1&2,
at Post - Mahi, Via Chhapi,
Pirojpura - Mahi Road, Taluka - Vadgum,
Dist - Banaskantha, North - Gujarat,
Pin - 385 210. India

Catalogue No. 02-05/PIF

www.sealexcel.com

design & print - contactus@almats.com

